

RUDDER ASSEMBLY MANUAL

This useful step-by-step manual has been prepared to help the first-time builder (with no previous building experience) to assemble the rudder tail kit for the Zenith aircraft, from a factory-supplied tail kit. The rudder tail section will require about 12 hours to assemble with just basic skills and tools, and will provide the builder with an excellent introduction to home-building an all-metal Zenith aircraft (in addition to completing the first assembly: the rudder).

Building your own aircraft is probably going to be one of the most challenging and rewarding things you will do in your lifetime: imagine, you'll be flying in an aircraft that you have built yourself! Few people get the sensation and freedom of flying. Even fewer also get the reward of flying a plane that they've built themselves!

Don't become overwhelmed when building the rudder kit. While it's true that an aircraft is a piece of complex machinery, it is also very straight forward, especially when building from a kit. It's normal that you may initially become overwhelmed and confused, but your initial fears and concerns will disappear as soon as the project starts coming together, and as you get a better understanding of the construction. Zenith aircrafts are well-designed light aircraft - engineered specifically as a first-time kit project, using proven materials and simple processes and systems.

This RUDDER ASSEMBLY MANUAL has been prepared as a supplement to the complete and detailed Drawings and Manuals for the ZODIAC CH 601, STOL CH 701 and STOL CH 801 series aircraft.

Read all the introductions before beginning assembly of the rudder.

NOTICE: This manual has been written and published strictly for informational purposes to aid in the construction of the Rudder Assembly. You should not consider the educational material in this manual to be the practice of general aviation nor is it intended for this guide to be a complete account of sheet metal aircraft technology: it is limited to the scope of the assembly of Zenith Aircraft kits.

This guide is not intended to replace, substitute or supersede any technical information contained in the actual Drawings (blueprints), Newsletter Updates, or any Federal Aviation Administration regulations. Information contained in this photo assembly guide has been obtained by Zenith Aircraft Company from sources believed to be reliable, however, we cannot guarantee the accuracy or completeness of any information published herein and we shall not be responsible for any errors, omissions, or potential damages arising out of use of this information.

T:\UserData\ZAC Engineering\General Manual\Rudder General.doc



Zenith Aircraft Company
www.zenithair.com

Revision (9/2005)
© 2002 Zenith Aircraft Co.

RUDDER ASSEMBLY
General Information - Page 1 of 18

Table of Contents

TABLE OF CONTENTS	2
INTRODUCTION.....	3
Background Information.....	3
Composition of Aluminum Alloys	4
Sheet-Metal Construction Made Easy	4
Design Background	5
Simplicity of Parts	6
Easy to Build.....	7
The Completed All-Metal Aircraft	7
GETTING STARTED	8
Required Tools	8
Tools You Need To Assemble The Kit.....	8
Using Your Tools Effectively	11
Kit Materials	13
Corrosion Inhibitor	15
General Building Tips.....	16
Additional Information & Resources.....	17
FAA Inspection & Documentation.....	18



INTRODUCTION

Background Information

Common sheet-metal construction, as used in the construction of the Zenith Aircraft kit, is most accurately described as “aluminum-alloy, semi-monocoque, and stressed skin construction.” This means that the metal used is an aluminum-based alloy, and that the airframe sections are designed and built so that the outer skin itself is part of the structure, with internal ribs, longerons, and bulkheads to distribute the loads. The metal parts are permanently joined with rivets or other fasteners.

Sheet-metal aircraft construction became a popular replacement to steel-tube (or wood) airframes covered by fabric because of its numerous advantages: Metal construction is more efficient because it doesn't need both a framework for structural strength (often accompanied by exterior braces) and a separate covering skin to provide the aerodynamic shape of the aircraft. Furthermore, sheet metal is not as delicate as fabric, and not subject to ongoing damage by moisture and sunlight (UV rays). Aluminum-alloy construction is stronger yet lighter, while being very durable. By designing structural members to carry the required loads and to resist stress in relation to the physical characteristics of the metal parts and fasteners, a metal aircraft provides superior strength and durability while lowering weight (thus increasing performance).

New and modern metal alloys and materials have allowed aviation technology to advance, and is the reason it continues to dominate over other aircraft building methods. Aluminum's unique combination of properties makes it one of the most versatile engineering and building materials in existence:

- Low weight / high strength relationship;
- Corrosion resistance, especially with newer alloys and modern primers;
- Low cost and widespread availability;
- Proven durability and resistance to sun and moisture;
- Existence of vast amounts of empirical data on its properties;
- Easy to work with: requires simple tools and processes, and does not require a temperature-controlled or dust-free environment, as with composites. Modern blind rivet fasteners have greatly simplified all-metal kit aircraft construction;
- Malleability: easy to form into many shapes, with almost no limit to the shapes it can be formed into;
- Environmentally friendly: few health hazards to worry about when working with sheet metal; recyclable;
- Easy to inspect: construction or materials flaws are easily detected, as are defective parts and damage.
- Simple to repair: rivets and fasteners can be easily removed to replace damaged parts or sections, and individual parts can be replaced without having to replace or rework an entire airframe section.



Additionally, a well-designed sheet-metal aircraft provides superior crashworthiness over other types, as an impact's energy is absorbed by progressively collapsing the metal structure, as opposed to splintering or shattering upon impact. Another important advantage often overlooked is the inherent lightning protection that a metal airframe offers - especially valuable for IFR operation.

2024-T4 and 6061-T6 are two of the most common alloys used in kit aircraft today, and are readily available in many forms at affordable prices. The more modern 6061-T6 alloys is a very versatile alloy for aircraft construction, providing superior corrosion resistance, good formability (easy to work with), flexibility and strength.

Composition of Aluminum Alloys

ALLOY	6061-T6	2024-T4
Copper	0.25	4.50
Silicon	0.60	
Manganese		0.60
Magnesium	1.00	1.50
Chromium	0.25	

Above indicates percentage of alloying elements in addition to pure aluminum.

Temper (-T) Designations

- T6: Solution heat treated and artificially aged
- T4: Solution heat treated

Sheet-Metal Construction Made Easy

As with most things, there are simple ways and then there are complicated and difficult ways of accomplishing the same goal. This is especially evident in aircraft design and construction: Making an aircraft easy to build starts at the design stage: A designer must not only be an expert in aerodynamics and stress analysis, but must also maintain the builder's perspective when designing an aircraft. Unfortunately, this is not the case with many engineers today: Often a design may be aerodynamically and structurally sound, but it will be so complex to put together that it requires a highly skilled builder and well-tooled factory environment to put together, making the aircraft unduly expensive to buy, time consuming to build, and costly to maintain. Other times the opposite may be true, where an aircraft may be quick and easy to build, but at the expense of aerodynamic efficiency and/or structural integrity.

It's easy for an engineer to design a complicated aircraft, and more challenging to design a simple one. For a kit aircraft to be successful, it must be relatively simple in terms of construction, assembly and systems: Not only is a simple design easier and more affordable to build, but also chances are that it will be well constructed by the amateur builder. There will be fewer opportunities for errors or poor workmanship. With a simple design, building time will be lower and less tools and skills will be needed to put the aircraft together, equating to a much higher completion rate than with a complex project.



Design Background

Chris Heintz, designer of the ZODIAC CH 601, STOL CH 701 and STOL CH 801, started his engineering career on complex factory-produced aircraft (Aerospatiale, Avions Robin (France) and de Havilland) where he became a seasoned aerodynamics and stress engineer. However, he also discovered that most of what he designed was complex and costly to produce. Thus, on his own, he designed an aircraft for his own personal use, and learned that there was an easier and better way to work with sheet metal, taking away the complexities while retaining the many advantages inherent in all-metal construction. Being an engineer and not a craftsman or mechanic, he incorporated this simplicity in his designs that he quickly completed. The success of this first design, and its appeal to amateur builders, made Heintz decide to strike out on his own in 1974 to manufacture aircraft kits and designs, making him a pioneer in the kit aircraft industry, which was in its infancy at the time. Over the past 26 years, Zenair Ltd., and Zenith Aircraft Company, have become major players in the kit industry, bringing to market over 12 successful all-metal designs. Over the past two decades, Heintz has not lost focus of what made his designs successful in the first place: design and construction simplicity. Actually, over this period, Zenith Aircraft kits have become even easier and quicker to build as new designs, building techniques and technology have continued to simplify the building process. In 1994, Heintz successfully obtained FAA type-certification on a new low-cost trainer aircraft design, the ZENITH CH 2000, which uses the same construction techniques developed by Zenair in its line of kit designs.

While volumes have been written just on the “fundamentals” of sheet-metal construction, building a simple all-metal aircraft does not require an airframe mechanic’s formal training, skills or tools. While it’s true that metal construction can require a full inventory of tools and skills, it’s equally true that simplified and modern forms of sheet metal construction are easier and quicker than many other forms of aircraft construction, while retaining metal construction’s inherent advantages.

From conception, Zenith Aircraft designs are developed for amateur builders and pilots. This is accomplished by using readily available materials and simple systems, and by designing aircraft that will produce the desired flight performances and characteristics yet remain easy to build.

The extensive use of blind rivets (instead of conventional “bucked” rivets) has contributed largely to simplifying all-metal construction. These modern fasteners are as simple to set as standard “pop” rivets, and don’t require the expertise and tools required for hammering and bucking convention rivets, such as pneumatic riveter, air compressor and an assortment of bucking bars. Aside from not having to purchase this expensive equipment and needing to become an expert at riveting, blind rivets represent a number of significant advantages to amateur builders:

- The rivets are pulled only from one side (hence the name “blind” rivet), unlike bucked rivets that need to be driven from one side and bucked on the other side. This means that one person can do blind riveting, and the builder does not need to exercise physical contortions to gain access behind the rivet when riveting sections together. Pulling blind rivets is nearly silent compared to the pounding noise of a pneumatic hammer, lending itself well for home projects (without driving the family and neighbors away).



- Thanks to the innate simplicity of pulling a blind rivet, the process is quick and foolproof. On all-metal kit aircraft like the Zenith aircraft, exterior skins are not counter-sunk for flush riveting. While perfectly smooth skins may be aesthetically pleasing, they have negligible impact on performance, especially when factoring in the hundreds of building hours it takes to achieve such a finish.
- Another advantage of blind rivets is their long grip area length, which means that the same rivet size may be used to fasten a wide range of material thickness, avoiding the need for a large inventory of different length rivets.
- While per unit cost is higher for blind rivets, they provide many advantages to homebuilders, and have become very popular with many modern all-metal kit aircraft, providing the required strength, durability, and building ease.

Simplicity of Parts

While aluminum alloys may be formed into nearly any shape imaginable, this usually requires specialized skills and costly tooling. Cost is greatly reduced by using off-the-shelf stock aviation-grade materials (flat sheet metal and rolled extrusions), and simple shapes and bends simplify manufacturing and assembly. For these reasons, the surface skins on Zenith Aircraft's aircraft are designed with single-curvature bends, as opposed to compound curves. Wherever possible, the internal structure is also made of straight, single-curvature parts, such as longerons, wing spars, and stiffeners. Internal ribs and bulkheads must be formed, and are stamped and hand formed using simple forming dies. A constant chord wing section minimizes the number of different formed parts and simplifies assembly.

Heintz' designs are easily recognized by their thick wing sections, common on many older designs like the DC-3. A thick, cantilever wing provides maximum strength at minimum weight, while also being aerodynamically efficient since there is no drag-inducing exterior bracing. The wing's main structural member is a thick single carry-through spar, made up of a sheet-metal web riveted to top and bottom extruded longerons. Thanks to the high strength of this spar, a relatively low number of wing ribs and stiffeners are needed, thus simplifying construction. The efficient use of parts in a design limits the number of parts required and reduces building time and cost.

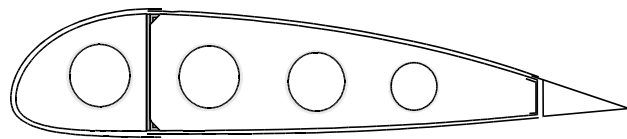

In the Zenith aircraft, all the parts and materials needed to complete the airframe are supplied in the standard kit. The philosophy behind the kit is to supply all the parts and components in such a state that a builder needs only basic skills and tools to put the aircraft together. That means that parts are supplied pre-formed and ready for assembly, and that specialized components, such as welded steel parts, wing spar assemblies, ribs and bulkheads are provided in a completed, ready-to-install state. Recent improvements to the kits, such as pre-drilled flat skins, further simplify assembly while minimizing required skills.

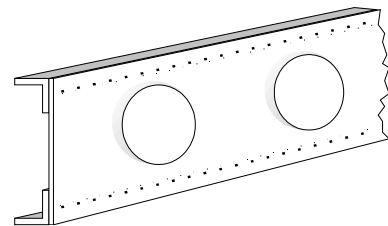

Easy to Build

For the amateur builder, sheet-metal construction offers distinct advantages: The modular construction of an all-metal aircraft lends itself well to the homebuilder. Unlike a welded steel frame or composite shell that takes up a lot of space right from the beginning, a metal aircraft is made up of smaller sections that are only joined together later, minimizing workshop space requirements. Using single-curvature or flat sections reduces the need for any jigs or assembly fixtures, allowing the builder to easily build-up sections on a flat workbench (saving the time and expense of making jigs). With a Zenith Aircraft kit, a builder measures, lines-up, drills and rivets the various components individually on the workbench, and only later are the assemblies joined together. "Clecocs" are temporary fasteners (hole clamps) that firmly hold the drilled sections together before rivets permanently fasten them. With Clecocs, whole sections of an aircraft can be temporarily assembled and joined, and then easily disassembled before final assembly and finishing.

When putting together an all-metal aircraft, assembly mistakes can often be fixed without having to replace a costly part. Simply re-aligning and drilling the part correctly can easily fix building errors. Importantly, errors in sheet-metal construction are easily identified, unlike a poor weld or lamination that may go by undetected. The "open" construction of a sheet-metal aircraft makes it easy to put together and is readily accessible to install controls and other components. Installing an antenna or landing light on a metal aircraft is very straightforward - even after a section has been completed (whereas the same task on a composite structure may prove very time consuming, if not impossible, after a section has been closed).

To prove how quick and easy Zenith Aircraft kits are to build, company staff has led volunteers in building and flying various Heintz designs within just seven days. In 1993, a Super ZODIAC CH 601 kit was assembled and flown during the one-week EAA Sun 'n Fun fly-in in Lakeland, Florida. Most builders of Zenith Aircraft kits are novices with no prior aircraft building experience.

The Completed All-Metal Aircraft

Once an all-metal aircraft is completed and flying, the inherent advantages of aluminum alloys continue to be apparent:

- Suitable for outdoor storage. The durability of a metal airframe makes it suitable for continuous outdoor storage, saving the owner ongoing costly hangar fees or the hassles of folding/removing the wings and trailering the aircraft home.
- Easy to Inspect. Both external and internal structures can easily be inspected once a metal airframe has been completed. This becomes an important safety factor as potential problems may be identified before they manifest themselves. Since the workmanship and condition can be thoroughly inspected even on an older aircraft, the resale value of an all-metal aircraft is often optimized.
- Easy Maintenance. The durability of an all-metal aircraft lowers ongoing maintenance requirements, and since most builders perform their own maintenance, this is accomplished with minimum downtime, cost, and complexity for the non-mechanic.



GETTING STARTED

YOUR WORKSHOP

WORKSHOP SPACE: Basically, all you need is a strong, level workbench, with workspace around the table. A basement or single car garage will provide plenty of room for most assemblies. Prepare the workshop before you get started, and clear away other clutter from your workspace. You don't need a temperature controlled or dust-free environment -- just an area you can comfortably work in. Assembly of a kit is a fairly quiet process (you won't drive your family or neighbors away).

Recommended table size: 12' x 4', which will fit in a single-car garage or basement workshop. You can easily build a workbench with particleboard or plywood (3/4" thickness) and support beams. Make sure that the workbench is sturdy, flat and level so that you can use it as a flat reference. Supporting the table on "saw-horses" is simple and portable.

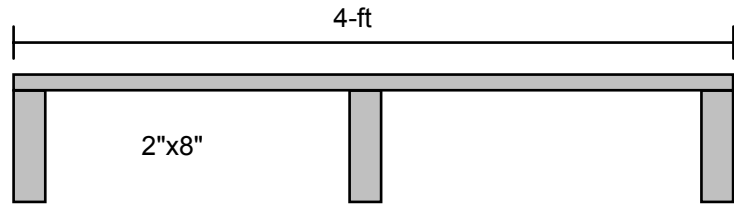

SIDE VIEW OF WORKBENCH TABLE

Required Tools

Following is a basic list of the required tools, with brief explanations on how to use the tools efficiently. This section is by no means meant to be exhaustive, as volumes have been written on aircraft tools, materials and procedures. It is meant to be a useful outline of which tools you will need and how to use them effectively for this project.

Tools You Need To Assemble the Kit

Only very basic tools are needed to assemble the ZODIAC kit. You probably have most of the required tools in your workshop already, and need to purchase only a few affordable ones specific to sheet-metal construction. You don't need a bending brake or sheet metal shear, and you don't have to learn about solid "conventional" riveting. You may be tempted to buy an air compressor and pneumatic tools (drills and riveter), but you really don't need them.

- **ELECTRIC HAND DRILL:** You'll need a standard "hardware store" electric hand drill. Preferably, use a high speed drill (2,500+ RPM), which makes drilling quicker and easier. A variable speed drill is often easier to use. Place a Rubber Washer at the drill bit shank - this way when you drill through a hole, the rubber washer will protect the material from being dented by the steel "chuck" of the drill.

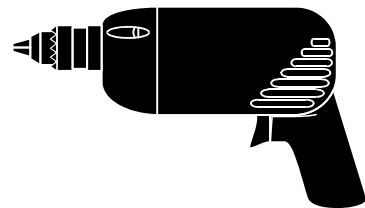

- **DRILL BITS:** You'll need a number of drill bits: Use the "numbered" drill sizes for rivet holes (which provide a slightly larger hole than the rivet size): Most drilling requires the #20 and 30 drill bit sizes, so get a few of each. Quality bits will stay sharper longer (making drilling easier).



DRILL SIZE	DECIMAL EQUIV.	RIVET / BOLT
# 40	0.0980	3/32" RIVET
# 30	0.1285	1/8" RIVET
# 20	0.1610	5/32" RIVET
3/16"	0.1875	3/16" BOLT
1/4"	0.250	1/4" BOLT
5/16"	0.3125	5/16" BOLT
3/8"	0.3750	3/8" BOLT

- **MEASURING TOOLS:** A ten or twelve foot **METRIC** tape measure is required. Some hardware stores don't carry metric tape



measures, but they're available in many stores. A steel ruler is also required, as well as a square. A spirit level and plumb line will be useful to assure that your workbench is flat and level, and to make sure that your parts (assemblies) are straight and level.

- **CLECOS:** These fasteners allow you to temporarily hold your sheet metal together without having to rivet. After drilling a hole, you insert the Cleco (with the pliers), and it holds the material together firmly while you drill out more holes. Taking them out is as easy as putting them in. Clecos are an excellent and vital tool while building. Generally, CLECOS are only available through aircraft tool supply shops. Remember: You need a set of Cleco pliers to use them.

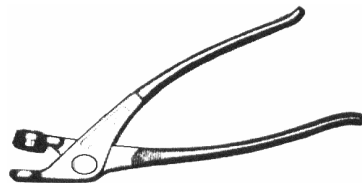
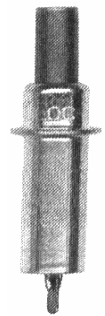

- **CLECO: Recommended Amounts:**

CLECO SIZE	CLECO COLOR	MINIMUM QTYS FOR TAIL KIT	MINIMUM QTYS FOR COMPLETE KIT		
			ZODIAC	STOL 701	STOL 801
3/32"	SILVER	5	50	50	50
1/8"	COPPER	50	200	200	100
5/32"	BLACK	10	200	60	300



- **HAND RIVETER:** For riveting, you only need a simple hand-riveting tool. You do not need a pneumatic riveting hammer and bucking bars, as all riveting in a kit is with blind rivets (that means that riveting is very easy, quiet, and only a one-person job). If you don't already have a "pop" riveter, purchase a lightweight heavy-duty professional model. If you have an air compressor, you may want to also use a pneumatic rivet puller.



- **RIVETER HEADS (changeable Nose Bushing piece):** Zenith Aircraft Company has developed a unique process for setting blind rivets which requires custom riveter heads. The process uses flush-type rivets, where the flush rivet head is formed into a domed-head by the riveting process. This provides a permanent, tight finish to all set rivets. To accomplish this, the riveter heads must be ground (machined) with a concave dome. 1/8" (A4) and 5/32" (A5) rivets are required to assemble the kit.

- **SHEET METAL SNIPS:** Good sheet metal snips make cutting and trimming sheet metal nearly as easy as cutting paper. We recommend "WISS" brand, which is readily available. You'll need a pair for left-hand cuts (Red Grips - M1) and a pair for right cuts (Green Grips - M1). Both pairs will also make straight cuts.

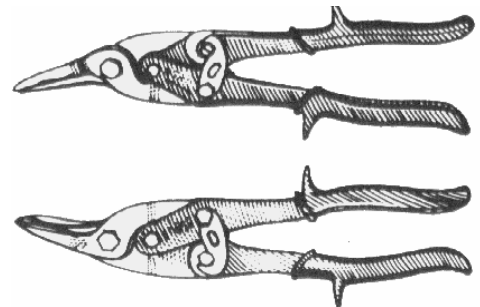

- **HAND FILES:** An assortment of small files for deburring and filing edges is required: FLAT, HALF ROUND, and ROUND files. Use sheet metal or "machinist" files, with a "SMOOTH CUT."

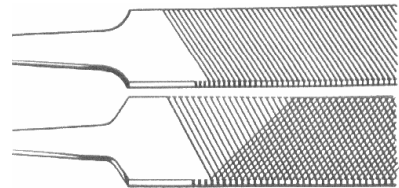

- **HAND HACKSAW:** A simple hacksaw with fine teeth (24 teeth per inch) is required to make straight cuts in extrusions and thicker aluminum. If you have a band saw, you can use it instead of the hacksaw.

- **OTHER TOOLS:** For building the complete airframe kit, you will also need the following: a set of standard wrenches/ ratchet set, screwdrivers, etc., hammer, various clamps, and other miscellaneous home shop tools. You will also find it useful to have a drill press and a bench vice (don't fasten aluminum aircraft parts in the steel grips: change the grips to aluminum, or cover the grooved steel grips to avoid damaging the parts). If you don't already have a specific tool, see if you can borrow one.

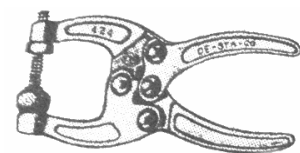

- **TOOLS YOU DON'T NEED TO ASSEMBLE THE KIT:** You don't need a bending brake, a sheet-metal shear, a press, and so on. All major bends and cuts have been made to the materials provided in the kit, all welded parts are supplied "ready to assemble" and the wing spars are factory solid-riveted. You also don't need flanging tools, as all lightening holes are pre-cut and flanged.



Using Your Tools Effectively

Following are useful tips and techniques on using your tools efficiently and effectively:

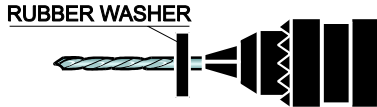
- **DRILLING** - hold the hand drill perpendicular to the material being drilled. Always keep drill-bits sharp (minimizes de-burring). Make sure that you are drilling the hole the proper size (verify drawings), and correct location. Balance the drill with both hands so that you have full control of the drill (avoiding "wandering" of the drill). Don't drill the same hole over more than required, as that will increase the size of the hole. You don't need to center punch where you will drill - a well marked spot will suffice. Adding a rubber washer by the shank will prevent damaging the material as you drill a hole through. (To make a rubber washer simply drill through a small piece of rubber hose cut in half). 

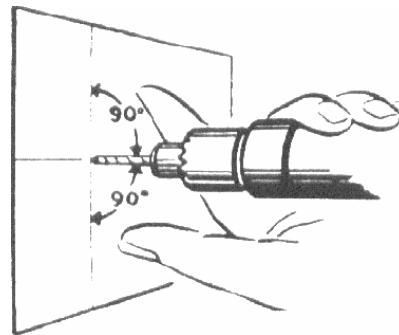
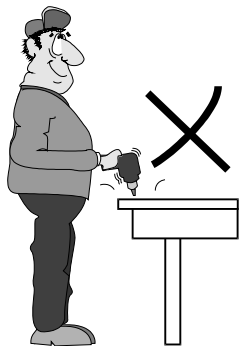

- **BLIND RIVETING:** The blind rivets are set with a standard hand riveter, with customized heads (nose bushings piece). The Avex blind rivets are very easy to set, and require access from one side only (compared to solid rivets which require access from both sides). Hold the hand riveter perpendicular to the material as you pull a rivet, pushing down on the riveter (against the material) as you squeeze. Make sure holes are de-burred before riveting (all surfaces, both sides).

A rivet can always be taken out: To drill out an existing rivet, drill out the rivet head without drilling through the hole. Then, using a nail, hammer the stem of the rivet out of the hole. This will not enlarge the rivet hole.

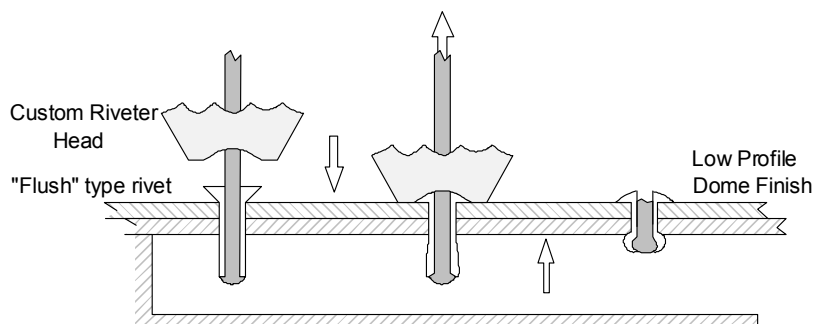

When there is a choice, the rivet head should be located on the side of the thinnest material riveted together, or on the outside of the aircraft. There is no need to flush-rivet.

DRILL NO.	40	30	20
Standard	(0.098")	(0.1285")	(0.1610")
Metric	2.5mm	3.2mm	4.0mm
Blind Rivets (AVEX)	A3	A4	A5

The blind rivet will fill in holes that may be slightly oversized as it expands. This is not the case with bolts.

- SNIPS - HOW TO CUT AND TRIM SHEET METAL:** Some sheet-metal parts need trimming, which is easily done with hand snips. Cutting is made easier by holding the snips at a slight angle to the material, and not closing the snips completely (only 1/2 to 3/4 of the scissors blade length). When cutting away a larger section, it is often easier to first make a rough cut (about 1/2" from final cut), and then making the final cut. The cut edge may be filed for smoothness, if required.
- DE-BURRING / FILING:** Parts often need to be de-burred after having been drilled or cut. Any burrs between two surfaces or along edges must be removed. The easiest way to remove a burr from a drilled hole is to use a large drill bit (+1/4"), and turn it by hand a few times in the smaller hole so that it removes the burr. Note: Make sure that only the burr is removed, and that you do not enlarge or "countersink" the hole. Do Not Use A Power Drill For This. You can also lightly pass over the holes with a flat file to remove the burrs (be careful not to scratch the material).

For sheet metal edges, use a smooth file, running it



BURR AFTER DRILLING



CORRECTLY DE-BURRED



COUNTERSUNK



lightly along the edge at an angle. Run your hand lightly along edges and over drilled holes to feel for burrs. Sharp edges may be very lightly filed to avoid cuts. For filing away larger sections, you can first use a coarser double-cut file. For final filing, use a smooth file and make sure that a filed section does not become "corrugated" from filing. Tool supply shops also have specialized de-burring tools available (for drilled holes and sheet metal edges). These are not required, but you may find them useful.



Kit Materials

Only quality materials are used in Zenith Aircraft Company kits. Structural materials supplied in the kit must meet Zenith Aircraft Company's strict requirements, and have been subject to numerous quality control tests. The parts supplied in the kit are professionally pre-formed at the factory so that the builder can begin assembly immediately, without special tools or jigs. The aircraft has been engineered to use these specific materials:

The aircraft is built primarily of quality aviation aluminum-alloy sheet metal. The **6061-T6** aluminum alloy provides high strength, flexibility and corrosion resistance. Generally, in the instructions the sheet metal is only referenced by thickness (i.e. .025, .016)

A4 and A5 AVEX BLIND RIVETS: The AVEX blind rivets are made from quality alloys, and are batch tested by Zenith Aircraft Company for shear strength before being shipped. These rivets are corrosion resistant, and the stem becomes locked in after being set. Also, not many different lengths are required for different diameters or thickness. In the Assembly Instructions, they are designated as **A4** (1/8) and **A5** (5/32). They have a design shear strength of 130 lbs. and 220 lbs. respectively. Use only AVEX rivets supplied with the kit. If additional rivets are required, contact Zenith Aircraft Company.

READING THE ASSEMBLY INSTRUCTIONS: The detailed Assembly Instructions have been prepared so that the complete airframe may be built from the parts supplied in the kit. The drawings are not to scale, and the provided measurements are metric (millimeters). All the required references are provided in the Assembly Instructions, but often only once (this may require some cross-referencing). For rivet holes, do not count the X's shown on the drawing: Either the pitch (distance between holes) is specified, or the number of holes (rivets) is specified. Updates to the Assembly Instructions are published in the Zenair Newsletter (back-issues are available).

WORKING TOLERANCES: When assembling the kit, the pre-formed parts fit together properly, but certain tolerances must be observed. Always follow the specified dimensions as closely as possible, but remember to be practical and use common sense (you're building a well-designed light aircraft, not a jet fighter). Follow these tolerances:

TYPE	INCHES	METRIC
Rivet Spacing	+/- 1/8"	+/- 3 mm
Assemblies	+/- 1/8"	+/- 3 mm
Parts	+/- 1/16"	+/- 1.5 mm



EDGE DISTANCE: When positioning rivets, you must provide proper "Edge Distance" (the distance from the rivet or rivet hole to the edge of the material) for structural strength. The edge distance should be about three times the rivet hole diameter, usually approx. 10 mm. (Two times the diameter is the minimum acceptable edge distance.)

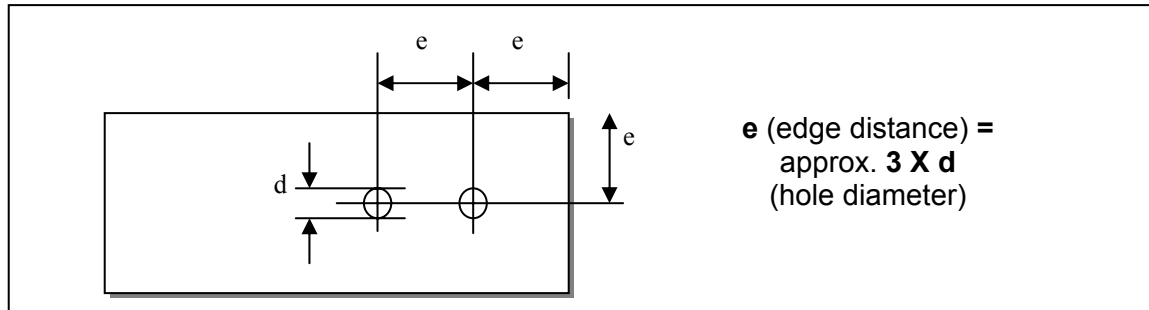

OVERLAPPING:

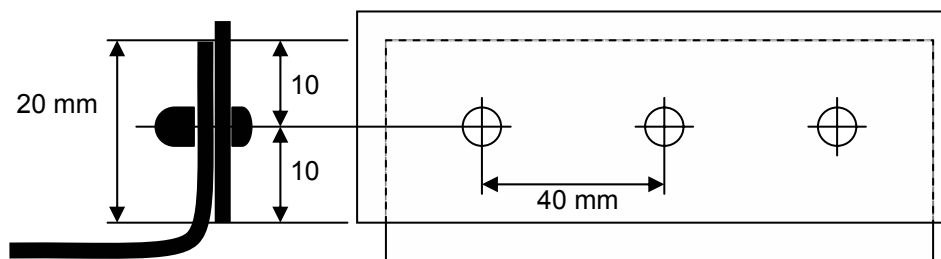

Rivet Spacing: 40 mm. = PITCH 40

SHEET METAL: Handle sheet metal parts with care. Sheet metal skins can easily be damaged (bent or kinked) when handled. With larger skins, it is recommended that two people handle them (one on each end).

Be careful with sharp corners and sheet-metal edges. Be especially careful with small children around sheet-metal corners at eye level (workbench height).

Always wear proper protection when working with power tools and around sharp sheet-metal parts.

Avoid scratching the material, but do not worry about light surface scratches. On spars and longerons, transverse scratches and nicks must be removed by filing and sanding lengthwise. Don't throw away cut-offs - you may find a use for such parts at a later date, or you can use them as "practice" pieces.

DRAWING AND MARKING: Before drilling or positioning parts together, draw the hole marks on the part(s). Use a felt-tip marker to draw or soft lead pencil. Use a straight edge to mark straight lines. To draw lines along a rib flange, it's often easier to simply use your hand (finger) as a reference, or you can use a simple "marking" tool.

Questions or problems as you are building? Think your question or problem through. Often the answer and solution is obvious and logical. If you can't solve it yourself, contact Zenith Aircraft Co. Remember, it's best that you submit technical questions on paper: draw us a sketch of your problem, and FAX or mail it to us for a prompt response.



Corrosion Protection

Aluminum alloys are the most widely used airplane material, and modern aluminum alloys such as 6061-T6 have excellent corrosion-resistant properties. A new all-metal aircraft will last for many years with minimal maintenance.

Applying additional corrosion protection to the internal surfaces will provide additional corrosion protection to the airframe. When applying corrosion protection, the minimum application is to cover the area where parts are riveted or bolted together (such as the overlap of the rib flange with the wing skins). Covering the complete part takes a little longer and adds additional weight; however, it will give a more uniform application.

When to apply corrosion protection: In the kit, the aluminum parts are supplied in the bare state, they have not been treated with a corrosion inhibitor: during storage keep the parts in a dry environment at all times.

First drill and cleco the parts as shown in the drawings and assembly manuals and then disassemble to deburr. Apply the corrosion protection on the internal structure and let dry completely reassembly of the parts. The traditional method is to apply Zinc Chromate primer on the individual parts.

Metal preparation before priming: Gently scuff up the surface with 3M Scotch-Brite general purpose hand pad (3M product P/N 7447+) or similar plastic pad (found on back side of some household kitchen sponges). Note: Do not use steel wool. De-grease the surface with a solvent, such as lacquer thinner, on a clean rag. Apply the corrosion protection (primer) on both mating surfaces, let dry, and then cleco the parts together for riveting.

Only apply on the inside surfaces; the corrosion protection primer may not be compatible with the top coat or external aircraft paint.

Zinc-Chromate (Zn-Cr) primer

Read and follow all safety labels - in some states ZnCr is prohibited.

Zinc chromate primer is available by mail order from some aircraft parts suppliers such as Aircraft Spruce & Specialty (www.aircraftspruce.com, tel. 800-861-3192), Wicks Aircraft Supply (www.wicks.com/aircraft, tel. 800-22-9425) or Wag-Aero (www.wagaero.com, 800-558-6868).

Zinc-Chromate (Zn-Cr) primer is available in various forms, such as a spray primer or a concentrated paste. The paste is too thick to brush on. You can either use the recommended solvent or simply use lacquer thinner as a reducer. With a spoon, scoop some out into another container, add solvent, and stir to dissolve the paste. Use a 2" bristle paint brush to apply the primer on the parts, if the solution looks too light, add in some more paste: all that is required is a thin coat of uniform color. Avoid a thick heavy coat that can also become brittle and flake off. A single application is applied to each part. Brushing the primer on the parts is one way to avoid breathing over-spray or vapors that may otherwise be associated with spraying.

Newer Approaches and Alternatives to Zinc Chromate Primer

Cortec – Tel: 651-429-1100 or Toll Free 1-800-4-CORTEC / www.cortecvci.com

An alternative to Zinc Chromate is Cortec VCI 373. This is a water based primer to treat the internal structure. This product lends itself well to spraying with HVLP spray equipment.

Corrosion X System - Tel: 1-800-638-7361

An alternative to applying primers is Corrosion X System: This is sprayed after the sections are assembled with a spray wand. A fine mist of "oil" is sprayed throughout the airframe.



General Building Tips

Following is general information on building your Zenith Aircraft Company kit aircraft. Please read this before you get started.

Following are a few useful general building tips that will help make your project a success:

1. Be consistent on this project and plan a working schedule: A few hours in the evenings and maybe a full day on the weekend (but don't forget your family: have them participate). It's much more efficient to work on the project consistently. Plan a work schedule, and follow it.
2. Use the help of friends, but remember that they can be of help yet can actually slow you down, too. Remember that you're in charge, and inspect their workmanship.
3. FOLLOW THE INSTRUCTIONS (it's much easier).
4. Take your time, proceed at a steady and comfortable pace, and be sure that you understand the drawings and instructions before you work the parts (thus avoiding mistakes). Don't hesitate to cross-reference or make notes, but don't spend unnecessary time reading, polishing, re-drilling or re-measuring, and avoid the tendency to be excessively perfectionist: Be productive!
5. Have confidence in yourself: YOU CAN DO IT. Overcome the initial fear that you've undertaken a complex project that's too demanding. However, don't become over confident either (which may lead to errors).
6. Avoid distractions and focus on the project at hand.
7. USE COMMON SENSE. Do not make things overly complicated for yourself, and think any questions or problems through. If you don't understand something, call or write the factory for guidance.
8. Have the proper tools and workshop, and use the tools correctly and efficiently.

WARNING: It is the builder's responsibility to assure that all components of the aircraft are made to the required specifications and standards. This applies to any and all parts, including parts and materials supplied in the kit. As we have no control over the builder's ability to construct and/or fly the aircraft, we do not take responsibility and give no warranty, expressed or implied, regarding structural integrity, performance, flight characteristics or safety of the builder's completed aircraft and aircraft components. Refer to the "Conditions of Sale and Warning Notice" on the Order Form for complete details.



Additional Information & Resources

NEWSLETTER: Subscribe to the ZENAIR NEWSLETTER. The Newsletter contains important updates to the Drawings and Manuals, as well as useful hints and tips on building your aircraft (from fellow builders and the factory). Use the enclosed form to subscribe, or write to:

Zenair News

1002 Heather Lane, Hartford, WI 53027-9045 USA

Tel: 262-966-7627 Email: sskrog@aol.com

BUILDER WORKSHOPS AND SEMINARS: Zenith Aircraft Company holds weekend workshops where you can actually complete the rudder tail section under the guidance of trained staff. You also learn many building tips and techniques. Contact the company for more information, and to register for the next workshop. Aeronautical engineer Chris Heintz, the designer of the ZODIAC, holds free lectures on light aircraft design and construction at the annual Oshkosh (Wisconsin) and Sun 'n Fun (Florida) fly-in conventions.

EXPERIMENTAL AIRCRAFT ASSOCIATION: Join the Experimental Aircraft Association (EAA) and also join a local EAA Chapter to meet with other builders and be part of the exciting world of sport aviation. Local builders can provide you with help (and lend you tools, as well!). EAA also has a Technical Counselor Program, which provides local technical help and guidance at no charge. Other programs / member benefits include the Flight Advisor Program, Aircraft Finance Plan, Aircraft Insurance Plan, and more. The Technical Counselor and Flight Advisor programs are highly recommended. Make use of these excellent resources. To join EAA, call 1-800-322-2412 or visit www.eaa.org.

RECOMMENDED READING: Many of the standard aircraft building / maintenance procedures are not explained in this manual. A good reference book for metal aircraft construction is the "*Standard Aircraft Handbook*" by L. Reithaier (Aero Publishing), and/or the "*Standard Aviation Maintenance Handbook*" (ISBN 0-89100-282-0)

CUSTOMER SUPPORT: All Zenith Aircraft kit builders automatically belong to a large and comprehensive builder support network. Every builder receives free technical support directly from the factory, with technical help provided from the same persons who design and build the kits. Quality support is just a phone call or FAX message away!

TECHNICAL SUPPORT - HOW TO REACH US:	
	ZENITH AIRCRAFT CO.
FAX:	573-581-0011 (24 HOURS)
MAIL:	ZENITH AIRCRAFT CO. PO BOX 650 MEXICO, MO. 65265-0659 USA
TELEPHONE:	(573) 581-9000 8:00 - 5:00 (CENTRAL), MON - FRI
INTERNET:	E-Mail: info@zenithair.com http://www.zenithair.com



Internet Online Builder Resources: There are numerous resources available to builders online, including drawings and assembly manuals updates, a builder listing database, etc. Register online for access to the exclusive builder resources: www.zenithair.com/bldr.htm

Technical questions are best answered when you can draw a sketch (FAX or mail it in). When corresponding, provide the aircraft **SERIAL NUMBER** and your complete name and address. Be sure to let us know of any address changes, or changes in ownership.

Designer Chris Heintz is also available for consultations about his kit designs. NOTE: While most technical questions will be promptly answered free of charge, responses requiring further calculations and/or engineering may entail an engineering fee. Before attempting to make any modifications or changes to a design, write or FAX Chris Heintz, c/o Zenair Ltd., Huronia Airport, Midland, ON L4R 4K8 Canada. Fax: 705-526-8022.

FAA Inspection & Documentation



Contact your local Federal Aviation Administration (FAA) office for information on the documentation and inspections required for your kit. Contact the FAA before the aircraft is completed and ready for inspection. Advisory Circular **20-27C** details the certification and registration process for amateur-built aircraft. AC No. **65-23A** outlines "certification of repairmen" (to obtain your repairman's certificate for inspections once the aircraft is completed). Rules change from time to time. Keep current of new requirements.

To request free up-to-date copies, contact:

US DOT
Publications Section 442.32
Washington DC, 20590

The FAA also publishes a number of useful publications on flight testing, maintenance and operation of experimental amateur-built aircraft. *The Guide to Federal Aviation Administration Publications* (FAA-APA-PG-13) is also available from the above address.

Useful Online Documentation:
<http://www.faa.gov/aircraft/rec/>

Documenting your kit construction:

- Keep a detailed building log, including photos.
- Keep all receipts and shipping documents.

Take photographs of sub-assemblies (before final covering). This will also be a commemorative diary of your project, and may be useful if you ever want to resell your aircraft.

